

This zoom lens is designed for use with Panasonic's applicable projectors.

*\*Please use the lens only on the specified Panasonic projector.*

**Specifications** (Specifications subject to change without notice.)

F value	1.84 - 2.14	
Focal distance (f)	10.80 mm - 12.52 mm [7/16 - 1/2 inches]	
Throw ratio	0.480 - 0.550:1 (16:10 aspect ratio) 0.480 - 0.550:1 (16:9 aspect ratio) 0.580 - 0.660:1 (4:3 aspect ratio)	
Dimensions	Width	179 mm [7 1/16 inches]
	Height	175 mm [6 7/8 inches]
	Depth	314 mm [12 3/8 inches]
Weight	5.20 kg (11.46 lbs)	
Applicable projector	PT-MZ20KL/PT-MZ17KL/PT-MZ14KL/PT-MZ11KL/PT-MZ16KL/PT-MZ13KL/PT-MZ10KL	

**Dimensions**

unit : mm [inch]  
This illustration is not drawn to scale.

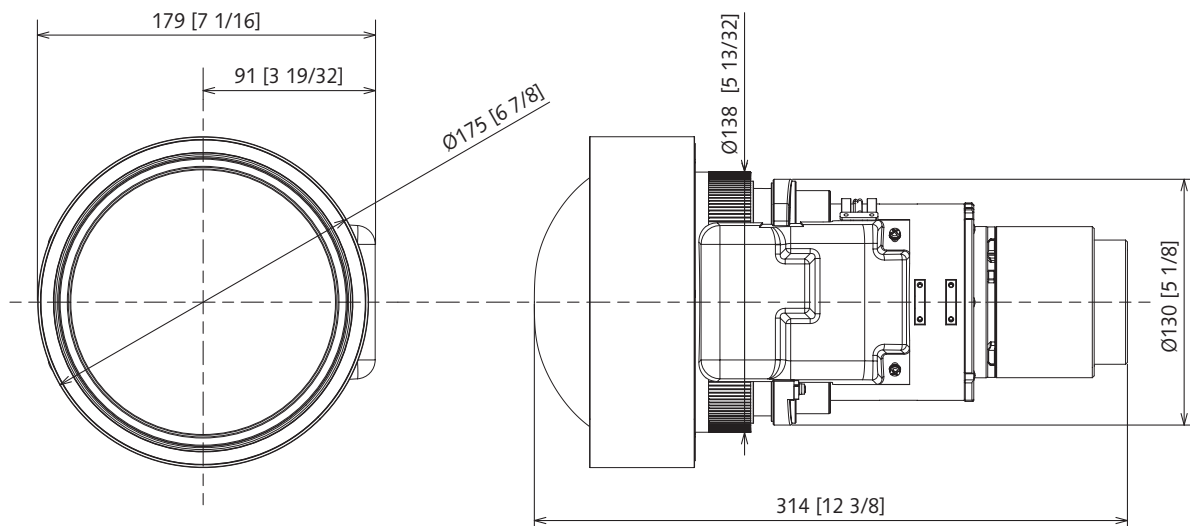
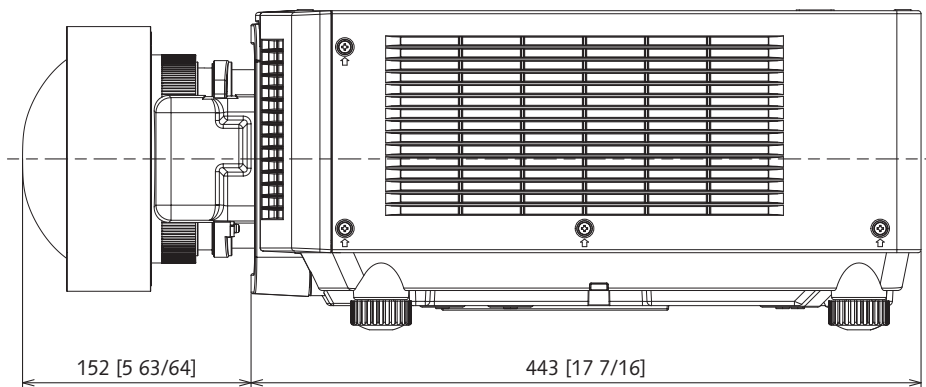

Figure attached to the [PT-MZ20KL/PT-MZ17KL/PT-MZ14KL/PT-MZ11KL/PT-MZ16KL/PT-MZ13KL/PT-MZ10KL] projector



Please read the projector's instruction manual for throw distances.