

**Zoom Lens**

This zoom lens is designed for use with Panasonic’s applicable projectors. The lens makes it possible to vary the projection distance by changing the focal distance.

**NOTE:** Please use the lens only on the specified Panasonic projector.

**Specifications**

F value:	2.5
Focal distance (f):	26.6– 36.4 mm
Throw ratio:	1.35–1.84:1 for PT-RQ32K/RQ22K (16:10 aspect ratio) 1.26–1.72:1 for PT-RZ31K/RZ21K (16:10 aspect ratio) 1.37–1.86:1 for PT-RS30K/RS20K (4:3 aspect ratio)
Auto Lens Identification Function	Compatible models : PT-RQ32K/RZ31K/RS30K/RQ22K/RZ21K/RS20K
Dimensions (W × H × D):	154 × 154 × 354 mm (6-1/16 × 6-1/16 × 13-15/16 inches)
Weight:	Approximately 6.2 kg* (13.7 lbs*)
Applicable projector	[Group A] PT-RZ21K/RS20K PT-RQ22K [Group B] PT-RZ31K/RS30K PT-RQ32K

-----

PT-RQ35K/RZ34K/RQ25K/RZ24K/RQ18K/RZ17K/RZ16K  
For these projectors see the individual spec files of the projectors

\*Average value. May differ depending on the actual unit.  
The throw ratio is an approximate value calculated by dividing the screen width by the projection distance.

**Dimensions**

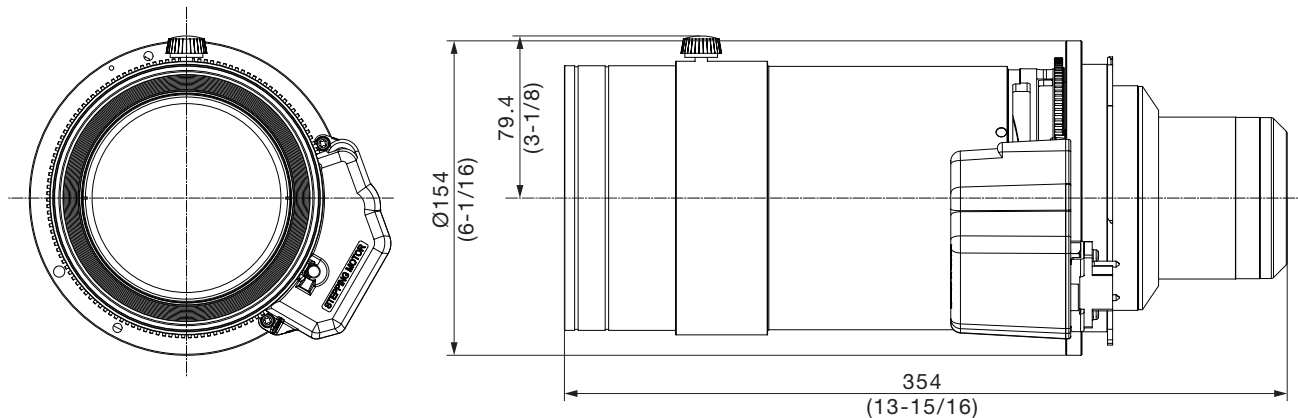

unit : mm (inch)  
**NOTE:** This illustration is not drawn to scale.

**NOTE:** Weights and dimensions shown are approximate. Specifications subject to change without notice.

[Group A]

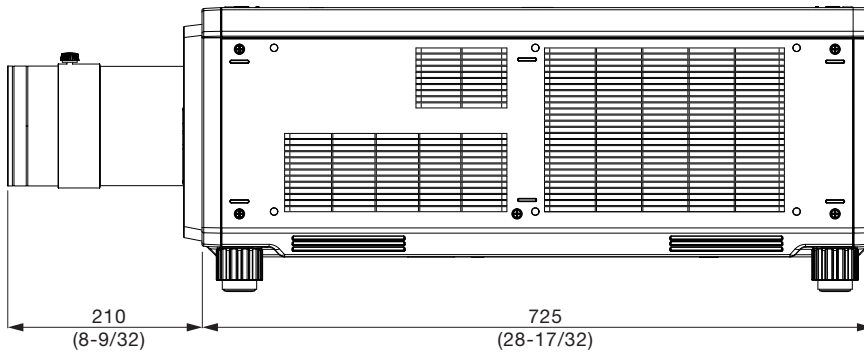

[Group B]

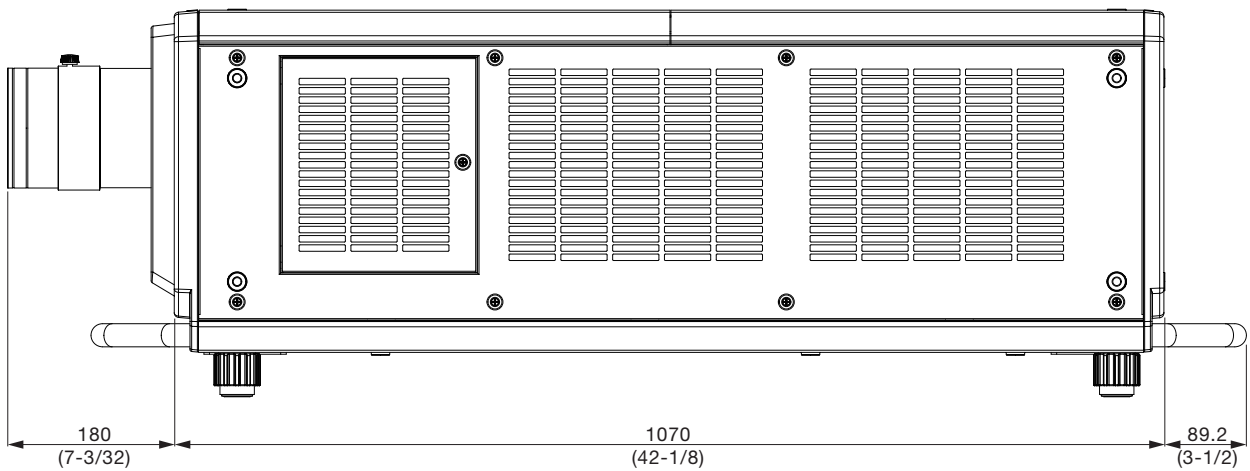

unit : mm (inch)  
NOTE: This illustration is not drawn to scale.

NOTE: Weights and dimensions shown are approximate. Specifications subject to change without notice.

Zoom Lens

Projection relationships

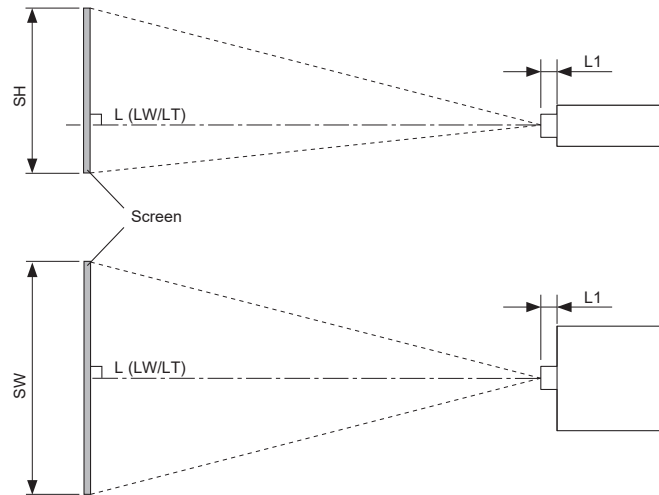
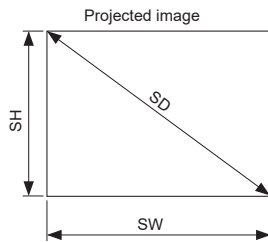

NOTE

- This diagram assumes that the size and position of the projected image will be adjusted so that the image fills the entire screen.
- This illustration is not drawn to scale.

L	Projection distance
	LW Minimum distance
	LT Maximum distance
L1	Lens protrusion dimension
SH	Projected image height
SW	Projected image width
SD	Projected image size

(Unit: m)

Projector model	Dimension for L1 (approximate value)
PT-RQ22K/RZ21K/RS20K	0.21
PT-RQ32K/RZ31K/RS30K	0.18

Projection distance

PT-RQ32K/RQ22K/RZ31K/RZ21K  
Aspect ratio 16:10

unit: meters (feet)

Projection size (Diagonal) [SD]	Projection size (Height) [SH]	Projection size (Width) [SW]	PT-RQ32K/RQ22K (2560×1600)		PT-RZ31K/RZ21K (WUXGA; 1920×1200)	
			Throw ratio[1.35-1.84:1]		Throw ratio[1.26-1.72:1]	
			Min [LW]	Max [LT]	Min [LW]	Max [LT]
1.778 m / 70"	0.942 (3.09)	1.508 (4.95)	1.99 (6.5)	2.73 (9.0)	1.85 (6.1)	2.54 (8.3)
2.032 m / 80"	1.077 (3.53)	1.723 (5.65)	2.28 (7.5)	3.14 (10.3)	2.13 (7.0)	2.92 (9.6)
2.286 m / 90"	1.212 (3.98)	1.939 (6.36)	2.58 (8.5)	3.54 (11.6)	2.40 (7.9)	3.30 (10.8)
2.540 m / 100"	1.346 (4.42)	2.154 (7.07)	2.88 (9.4)	3.95 (13.0)	2.68 (8.8)	3.68 (12.1)
3.048 m / 120"	1.615 (5.30)	2.585 (8.48)	3.47 (11.4)	4.76 (15.6)	3.23 (10.6)	4.43 (14.5)
3.810 m / 150"	2.019 (6.62)	3.231 (10.60)	4.36 (14.3)	5.97 (19.6)	4.06 (13.3)	5.57 (18.3)
5.080 m / 200"	2.692 (8.83)	4.308 (14.13)	5.84 (19.2)	7.99 (26.2)	5.44 (17.8)	7.45 (24.4)
6.350 m / 250"	3.365 (11.04)	5.385 (17.67)	7.32 (24.0)	10.02 (32.9)	6.83 (22.4)	9.34 (30.6)
7.620 m / 300"	4.039 (13.25)	6.462 (21.20)	8.80 (28.9)	12.04 (39.5)	8.21 (26.9)	11.23 (36.8)
8.890 m / 350"	4.712 (15.46)	7.539 (24.73)	10.28 (33.7)	14.07 (46.2)	9.59 (31.5)	13.12 (43.0)
10.160 m / 400"	5.385 (17.67)	8.616 (28.27)	11.76 (38.6)	16.09 (52.8)	10.97 (36.0)	15.01 (49.2)
12.700 m / 500"	6.731 (22.08)	10.770 (35.33)	14.73 (48.3)	20.14 (66.1)	13.74 (45.1)	18.79 (61.6)
15.240 m / 600"	8.077 (26.50)	12.923 (42.40)	17.69 (58.0)	24.19 (79.4)	16.50 (54.1)	22.57 (74.0)
17.780 m / 700"	9.423 (30.92)	15.077 (49.47)	20.65 (67.7)	28.24 (92.7)	19.27 (63.2)	26.35 (86.5)
20.320 m / 800"	10.770 (35.33)	17.231 (56.53)	23.61 (77.5)	32.29 (105.9)	22.03 (72.3)	30.13 (98.9)
22.860 m / 900"	12.116 (39.75)	19.385 (63.60)	26.58 (87.2)	36.33 (119.2)	24.80 (81.4)	33.90 (111.2)
25.400 m / 1000"	13.462 (44.17)	21.539 (70.67)	29.54 (96.9)	40.38 (132.5)	27.56 (90.4)	37.68 (123.6)

Zoom Lens

PT-RQ32K/RQ22K/RZ31K/RZ21K/RS30K/RS20K  
Aspect ratio 16:9

unit: meters (feet)

Projection size (Diagonal) [SD]	Projection size (Height) [SH]	Projection size (Width) [SW]	PT-RQ32K/RQ22K (2560×1440)		PT-RZ31K/RZ21K (1920×1080)		PT-RS30K/RS20K (1440×788)	
			Throw ratio[1.35-1.84:1]		Throw ratio[1.26-1.72:1]		Throw ratio[1.37-1.86:1]	
			Min [LW]	Max [LT]	Min [LW]	Max [LT]	Min [LW]	Max [LT]
1.778 m / 70"	0.872 (2.86)	1.550 (5.09)	2.04 (6.7)	2.81 (9.2)	1.90 (6.2)	2.62 (8.6)	2.07 (6.8)	2.84 (9.3)
2.032 m / 80"	0.996 (3.27)	1.771 (5.81)	2.35 (7.7)	3.23 (10.6)	2.19 (7.2)	3.00 (9.8)	2.37 (7.8)	3.26 (10.7)
2.286 m / 90"	1.121 (3.68)	1.992 (6.54)	2.65 (8.7)	3.64 (11.9)	2.47 (8.1)	3.39 (11.1)	2.68 (8.8)	3.68 (12.1)
2.540 m / 100"	1.245 (4.08)	2.214 (7.26)	2.96 (9.7)	4.06 (13.3)	2.76 (9.1)	3.78 (12.4)	2.99 (9.8)	4.10 (13.5)
3.048 m / 120"	1.494 (4.90)	2.657 (8.72)	3.57 (11.7)	4.89 (16.0)	3.32 (10.9)	4.56 (15.0)	3.61 (11.8)	4.94 (16.2)
3.810 m / 150"	1.868 (6.13)	3.321 (10.90)	4.48 (14.7)	6.14 (20.1)	4.18 (13.7)	5.72 (18.8)	4.53 (14.9)	6.20 (20.3)
5.080 m / 200"	2.491 (8.17)	4.428 (14.53)	6.00 (19.7)	8.22 (27.0)	5.60 (18.4)	7.66 (25.1)	6.07 (19.9)	8.31 (27.3)
6.350 m / 250"	3.113 (10.21)	5.535 (18.16)	7.53 (24.7)	10.30 (33.8)	7.02 (23.0)	9.61 (31.5)	7.60 (24.9)	10.41 (34.2)
7.620 m / 300"	3.736 (12.26)	6.641 (21.79)	9.05 (29.7)	12.38 (40.6)	8.44 (27.7)	11.55 (37.9)	9.14 (30.0)	12.51 (41.0)
8.890 m / 350"	4.358 (14.30)	7.748 (25.42)	10.57 (34.7)	14.46 (47.4)	9.86 (32.3)	13.49 (44.3)	10.68 (35.0)	14.61 (47.9)
10.160 m / 400"	4.981 (16.34)	8.855 (29.05)	12.09 (39.7)	16.54 (54.3)	11.28 (37.0)	15.43 (50.6)	12.22 (40.1)	16.71 (54.8)
12.700 m / 500"	6.226 (20.43)	11.069 (36.32)	15.14 (49.7)	20.70 (67.9)	14.12 (46.3)	19.32 (63.4)	15.30 (50.2)	20.92 (68.6)
15.240 m / 600"	7.472 (24.51)	13.283 (43.58)	18.18 (59.6)	24.86 (81.6)	16.96 (55.6)	23.20 (76.1)	18.37 (60.3)	25.12 (82.4)
17.780 m / 700"	8.717 (28.60)	15.497 (50.84)	21.23 (69.7)	29.02 (95.2)	19.81 (65.0)	27.08 (88.8)	21.45 (70.4)	29.33 (96.2)
20.320 m / 800"	9.962 (32.68)	17.710 (58.10)	24.27 (79.6)	33.19 (108.9)	22.65 (74.3)	30.97 (101.6)	24.52 (80.4)	33.53 (110.0)
22.860 m / 900"	11.207 (36.77)	19.924 (65.37)	27.32 (89.6)	37.35 (122.5)	25.49 (83.6)	34.85 (114.3)	27.60 (90.6)	37.74 (123.8)
25.400 m / 1000"	12.453 (40.86)	22.138 (72.63)	30.36 (99.6)	41.51 (136.2)	28.33 (92.9)	38.73 (127.1)	30.68 (100.7)	41.94 (137.6)

PT-RQ32K/RQ22K/RZ31K/RZ21K/RS30K/RS20K  
Aspect ratio 4:3

unit: meters (feet)

Projection size (Diagonal) [SD]	Projection size (Height) [SH]	Projection size (Width) [SW]	PT-RQ32K/RQ22K (2133×1600)		PT-RZ31K/RZ21K (1600×1200)		PT-RS30K/RS20K (SXGA+; 1400×1050)	
			Throw ratio[1.63-2.22:1]		Throw ratio[1.52-2.07:1]		Throw ratio[1.37-1.86:1]	
			Min [LW]	Max [LT]	Min [LW]	Max [LT]	Min [LW]	Max [LT]
1.778 m / 70"	1.067 (3.50)	1.422 (4.67)	2.26 (7.4)	3.11 (10.2)	2.10 (6.9)	2.89 (9.5)	1.89 (6.2)	2.60 (8.5)
2.032 m / 80"	1.219 (4.00)	1.626 (5.33)	2.60 (8.5)	3.56 (11.7)	2.42 (7.9)	3.32 (10.9)	2.17 (7.1)	2.99 (9.8)
2.286 m / 90"	1.372 (4.50)	1.829 (6.00)	2.93 (9.6)	4.02 (13.2)	2.73 (9.0)	3.75 (12.3)	2.46 (8.1)	3.37 (11.1)
2.540 m / 100"	1.524 (5.00)	2.032 (6.67)	3.27 (10.7)	4.48 (14.7)	3.04 (10.0)	4.18 (13.7)	2.74 (9.0)	3.76 (12.3)
3.048 m / 120"	1.829 (6.00)	2.438 (8.00)	3.94 (12.9)	5.40 (17.7)	3.67 (12.0)	5.03 (16.5)	3.30 (10.8)	4.53 (14.9)
3.810 m / 150"	2.286 (7.50)	3.048 (10.00)	4.94 (16.2)	6.77 (22.2)	4.61 (15.1)	6.31 (20.7)	4.15 (13.6)	5.69 (18.7)
5.080 m / 200"	3.048 (10.00)	4.064 (13.33)	6.62 (21.7)	9.06 (29.7)	6.17 (20.2)	8.45 (27.7)	5.56 (18.2)	7.62 (25.0)
6.350 m / 250"	3.810 (12.50)	5.080 (16.67)	8.30 (27.2)	11.36 (37.3)	7.74 (25.4)	10.59 (34.7)	6.97 (22.9)	9.55 (31.3)
7.620 m / 300"	4.572 (15.00)	6.096 (20.00)	9.98 (32.7)	13.65 (44.8)	9.30 (30.5)	12.73 (41.8)	8.39 (27.5)	11.48 (37.7)
8.890 m / 350"	5.334 (17.50)	7.112 (23.33)	11.65 (38.2)	15.94 (52.3)	10.87 (35.7)	14.87 (48.8)	9.80 (32.2)	13.41 (44.0)
10.160 m / 400"	6.096 (20.00)	8.128 (26.67)	13.33 (43.7)	18.23 (59.8)	12.43 (40.8)	17.01 (55.8)	11.21 (36.8)	15.34 (50.3)
12.700 m / 500"	7.620 (25.00)	10.160 (33.33)	16.68 (54.7)	22.82 (74.9)	15.56 (51.0)	21.29 (69.8)	14.03 (46.0)	19.20 (63.0)
15.240 m / 600"	9.144 (30.00)	12.192 (40.00)	20.04 (65.7)	27.40 (89.9)	18.69 (61.3)	25.56 (83.9)	16.86 (55.3)	23.05 (75.6)
17.780 m / 700"	10.668 (35.00)	14.224 (46.67)	23.39 (76.7)	31.98 (104.9)	21.82 (71.6)	29.84 (97.9)	19.68 (64.6)	26.91 (88.3)
20.320 m / 800"	12.192 (40.00)	16.256 (53.33)	26.75 (87.8)	36.57 (120.0)	24.95 (81.9)	34.12 (111.9)	22.51 (73.9)	30.77 (101.0)
22.860 m / 900"	13.716 (45.00)	18.288 (60.00)	30.10 (98.8)	41.15 (135.0)	28.09 (92.2)	38.40 (126.0)	25.33 (83.1)	34.63 (113.6)
25.400 m / 1000"	15.240 (50.00)	20.320 (66.67)	33.45 (109.7)	45.73 (150.0)	31.22 (102.4)	42.67 (140.0)	28.16 (92.4)	38.49 (126.3)

Zoom Lens

Calculation of the projection distance

Aspect ratio 16:10

unit: meters

PT-RQ32K/RQ22K	minimum	$LW (m) = (\text{diagonal screen size in inches}) \times 0.0296 - 0.0867$
	maximum	$LT (m) = (\text{diagonal screen size in inches}) \times 0.0405 - 0.1025$
PT-RZ31K/RZ21K	minimum	$LW (m) = (\text{diagonal screen size in inches}) \times 0.0277 - 0.0867$
	maximum	$LT (m) = (\text{diagonal screen size in inches}) \times 0.0378 - 0.1025$

Aspect ratio 16:9

unit: meters

PT-RQ32K/RQ22K	minimum	$LW (m) = (\text{diagonal screen size in inches}) \times 0.0304 - 0.0867$
	maximum	$LT (m) = (\text{diagonal screen size in inches}) \times 0.0416 - 0.1025$
PT-RZ31K/RZ21K	minimum	$LW (m) = (\text{diagonal screen size in inches}) \times 0.0284 - 0.0867$
	maximum	$LT (m) = (\text{diagonal screen size in inches}) \times 0.0388 - 0.1025$
PT-RS30K/RS20K	minimum	$LW (m) = (\text{diagonal screen size in inches}) \times 0.0308 - 0.0867$
	maximum	$LT (m) = (\text{diagonal screen size in inches}) \times 0.0420 - 0.1025$

Aspect ratio 4:3

unit: meters

PT-RQ32K/RQ22K	minimum	$LW (m) = (\text{diagonal screen size in inches}) \times 0.0335 - 0.0867$
	maximum	$LT (m) = (\text{diagonal screen size in inches}) \times 0.0458 - 0.1025$
PT-RZ31K/RZ21K	minimum	$LW (m) = (\text{diagonal screen size in inches}) \times 0.0313 - 0.0867$
	maximum	$LT (m) = (\text{diagonal screen size in inches}) \times 0.0428 - 0.1025$
PT-RS30K/RS20K	minimum	$LW (m) = (\text{diagonal screen size in inches}) \times 0.0282 - 0.0867$
	maximum	$LT (m) = (\text{diagonal screen size in inches}) \times 0.0386 - 0.1025$

Shift range

Optical axis shift function allows to shift the position of a projected image as shown below.

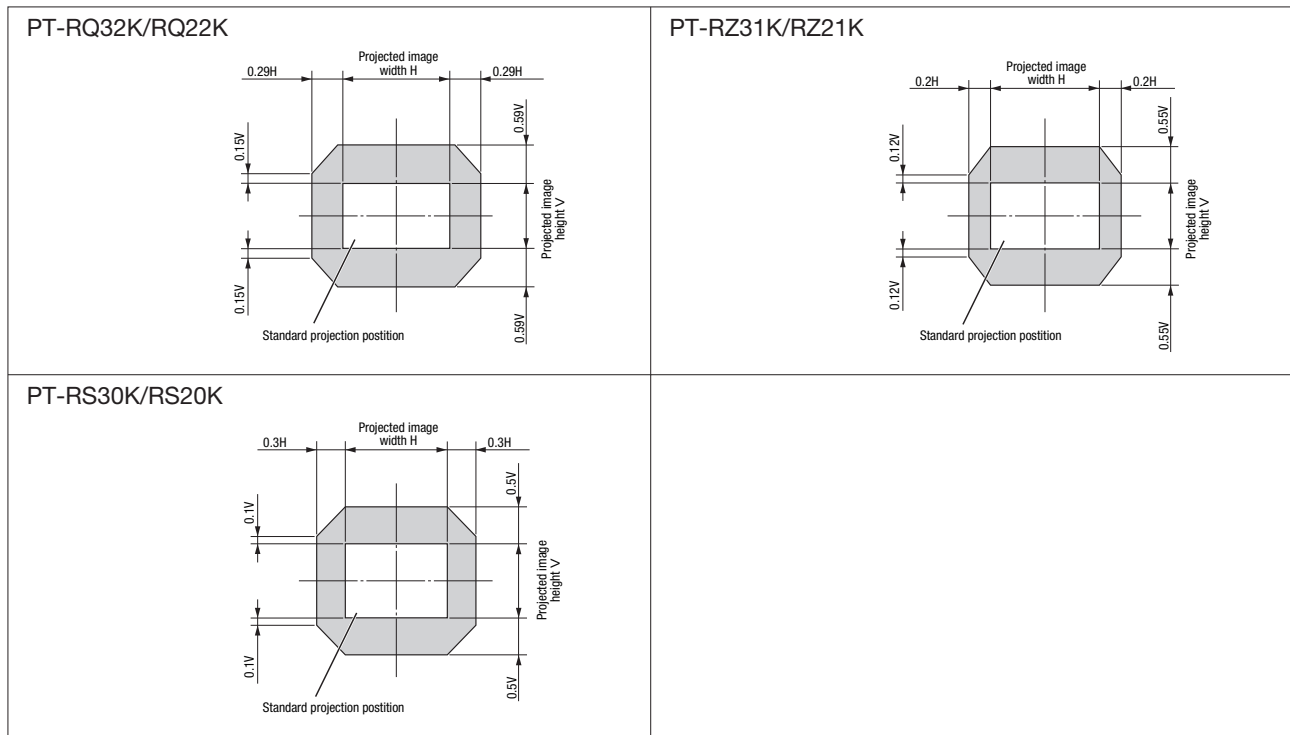

Zoom Lens

Keystone correction range

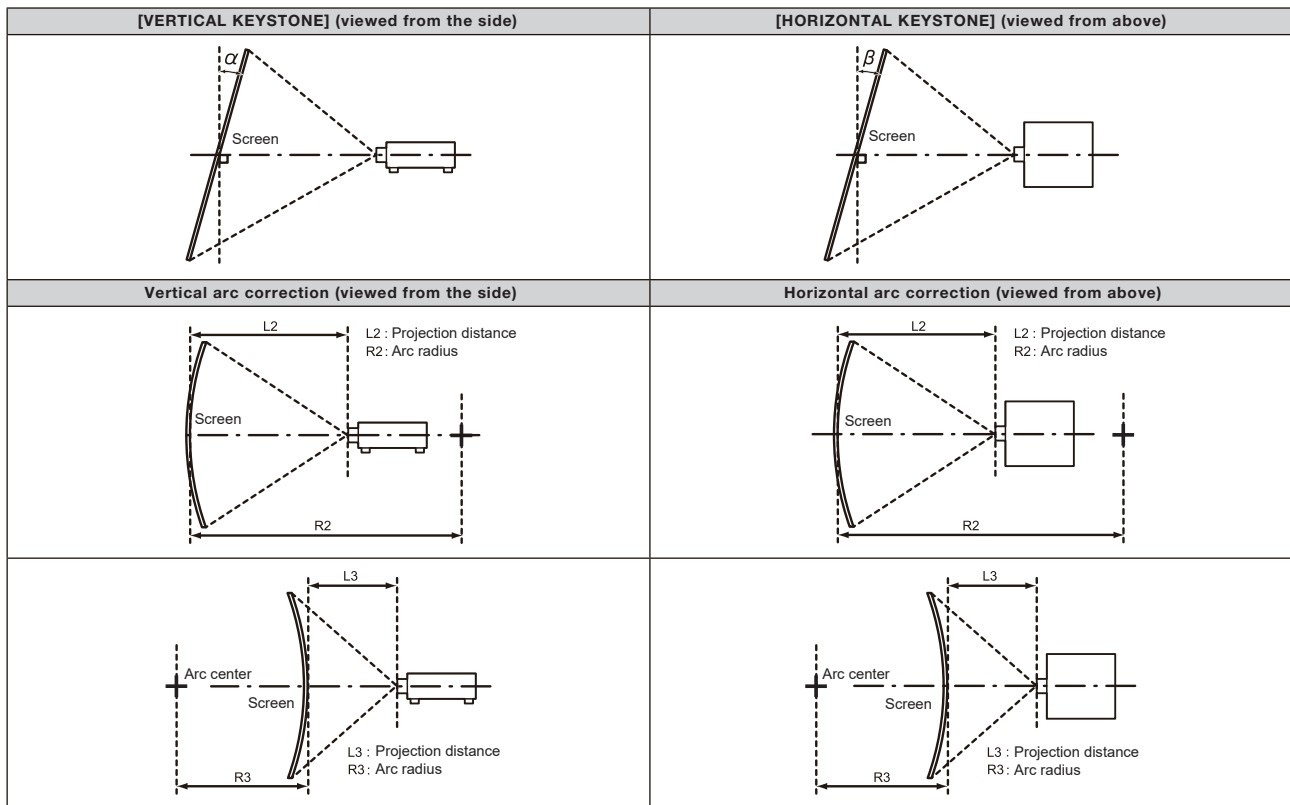

Standard status

Projector Model No.	Only [KEYSTONE] used		[KEYSTONE] and [CURVED CORRECTION] used together		Only [CURVED CORRECTION] used			
	Vertical keystone correction angle $\alpha$ (°)	Horizontal keystone correction angle $\beta$ (°)	Vertical keystone correction angle $\alpha$ (°)	Horizontal keystone correction angle $\beta$ (°)	Min. value of R2/L2	Min. value of 3/L3	Min. value of R2/L2	Min. value of R3/L3
PT-RQ32K/RQ22K	± 30	± 15	± 8	± 8	1.1	2.6	0.6	1.5
PT-RZ31K/RZ21K RS30K/RS20K	± 40	± 15	± 20	± 15	1.1	2.6	0.6	1.5

When using the optional upgrade kit (ET-UK20)

Projector Model No.	Only [KEYSTONE] used		[KEYSTONE] and [CURVED CORRECTION] used together		Only [CURVED CORRECTION] used			
	Vertical keystone correction angle $\alpha$ (°)	Horizontal keystone correction angle $\beta$ (°)	Vertical keystone correction angle $\alpha$ (°)	Horizontal keystone correction angle $\beta$ (°)	Min. value of R2/L2	Min. value of 3/L3	Min. value of R2/L2	Min. value of R3/L3
PT-RQ32K/RQ22K	± 30	± 15	± 8	± 8	0.9	2.0	0.5	1.1
PT-RZ31K/RZ21K RS30K/RS20K	± 40	± 40	± 20	± 15	0.9	2.0	0.5	1.1